

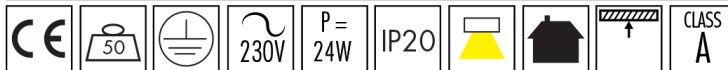

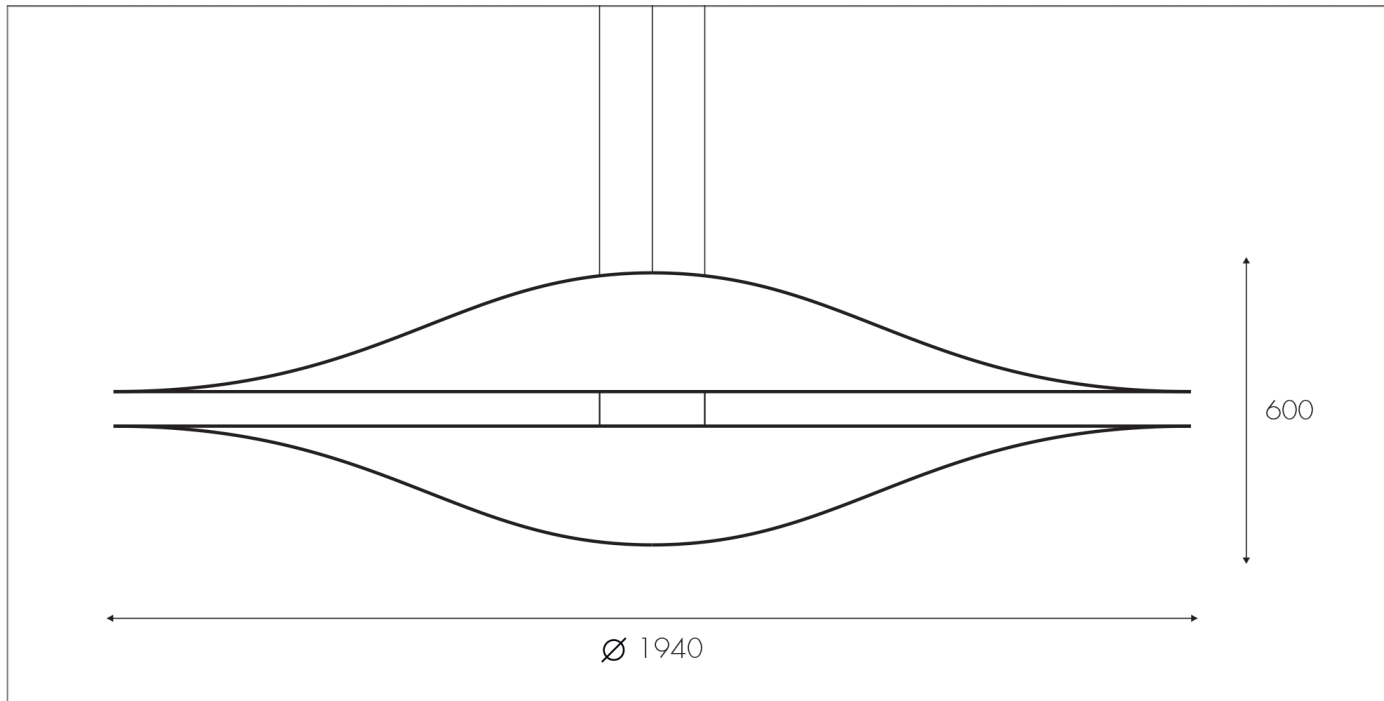



SKYBEAMER 200

design by Mai Waelkens



SK200P-LH-(COLOUR)

YEAR OF DESIGN	2014
MATERIAL	Polystyreen reinforced with glass fiber Handmade*
PRODUCT CODE	SK200P-LH-(colour)
TYPE	Pendant Light
COLOUR	 White glossy (001)  Black glossy (002)  Red glossy (003)  White/Gold (002-G)  Black/Gold (002-G)  On request

	LED (OSRAM 827) CRI > 80 2700 K 4.3 W
---	--

	Cable Length 3 m 3x steel cable
---	------------------------------------

	Ceiling rose
DIAMETER	90 mm
COLOR	White
MATERIAL	Metal

* Each object is 100% made by hand. Skybeamer 200 is a truly unique piece.
Irregularities and unevennesses in form, colour and shape can occur.